







Email: orders@adpaustralia.com.au | Phone: (02) 4271 2444

Store:	Order Date:
Store Contact Name:	Purchase Order Number:
Store Phone Number:	

1 Choose from the following components to create your custom Waverley

 <p>146mm Curved End (v-groove) Cannot customise MWAFFES0146WH (not sold separately) - \$599.00*</p>	 <p>446mm wide Drawer (v-groove) Cannot customise MWAFFAS0446WH - \$1,249.00*</p>	 <p>300mm Open Shelf (Standard Size) Cannot customise MWAFFSS0300WH - \$599.00*</p>
 <p>16mm End panel To be used when drawer box is against wall MWAFFES0016WH - \$99.00*</p>	 <p>598mm wide Drawer (v-groove) Cannot customise MWAFFAS0598WH - \$1,449.00*</p>	 <p>Custom Width Open Shelf Specify length between 301mm to 900mm MWAFFSS3090WH - \$799.00*</p>

*20mm Cherry Pie benchtop included in pricing, 25% surcharge applies for 20mm Caesarstone benchtop
For benchtop options please add the following to end of product code: CP = Cherry Pie, CS = Caesarstone

Starting from left to right, select a minimum of 3 modular components (1 from each column)

Note: Maximum benchtop length is 2.2m

A (select 1 only) →	B (select 1 only) →	C (select 1 only) →	D (select 1 only) →	E (select 1 only)
Curved end	446 Drawer	446 Drawer	446 Drawer	Curved end
300 Open Shelf	598 Drawer	598 Drawer	598 Drawer	300 Open Shelf
Custom Length Open Shelf	300 Open Shelf	300 Open Shelf	300 Open Shelf	Custom Length Open Shelf
Specify length between 301-900mm: _____ mm	Custom Length Open Shelf	Custom Length Open Shelf	Custom Length Open Shelf	Specify length between 301-900mm: _____ mm
16mm End panel	Specify length between 301-900mm: _____ mm	Specify length between 301-900mm: _____ mm	Specify length between 301-900mm: _____ mm	16mm End panel
		Curved end	Curved end	NONE
		16mm End panel	16mm End panel	
			NONE	
	<i>Select if basin is positioned over this drawer (cannot be positioned over open shelf)</i>	<i>Select if basin is positioned over this drawer (cannot be positioned over open shelf)</i>	<i>Select if basin is positioned over this drawer (cannot be positioned over open shelf)</i>	See page 3 for examples.

Note: Curved End not sold separately

2 Please sketch and label your Modular Waverley Vanity - Front and Top view

3 Installation Configuration

Please specify the positioning of your vanity:

Freestanding
(not against wall)

Between walls (both ends against a wall)

Specify total length between walls:

_____ mm

Left End against wall

Right End against wall

5 Cabinet Finish

Coastal Oak Woodmatt

Prime Oak Woodmatt

Florentine Walnut

Bottega Oak Woodmatt

Tasmanian Oak Woodmatt

Ultra White Matte (note: open shelf/end panel will be made in Polar White Silk Matte)

Please specify if Open Shelf is a different woodgrain or silk colour (excludes polyurethane)

Colour: _____

7 Push-to-Open or Handle

Push-to-Open

HANDLE OPTIONS

Aria	Blaze 350mm	Francis
Matte White	Matte White	Matte White
Matte Black	Matte Black	Matte Black
Brushed Nickel	Brushed Nickel	Brushed Nickel
Brushed Brass	Brushed Brass	Brushed Brass
Brushed Copper	Brushed Copper	Brushed Copper

9 In-Drawer Power Point

ADDITIONAL COST

Centre Drawer

Left Drawer

Right Drawer

11 Submit Your Order

Please email your order to orders@adpastralia.com.au

4 Benchtop Configuration

Both ends curved



Left end curved
(Right end straight)



Both ends straight



Right end curved
(Left end straight)



6 Benchtop Finish

Cherry Pie (20mm)*

Caesarstone (20mm)

Colour: _____

*When ordering Bright White Cherry Pie please specify 12mm or 20mm.

All other colours available in 20mm only.

8 Basin & Tap Hole

BASIN (Above-Counter only)

Name: _____

Code: _____

Colour: _____

Basin(s) will always be positioned over a Drawer, specify position on page 1. Basins cannot be positioned over an Open Shelf. Above-counter basins only.

TAP HOLE

0 Tapholes

1 Taphole
(12 o'clock only)

3 Tapholes
(12 o'clock only)

10 Plug & Waste Colour

Chrome (supplied with vanity)

Brushed Nickel (additional cost)

Gloss White (additional cost)

Brushed Brass (additional cost)

Matte White (additional cost)

Brushed Copper (additional cost)

Matte Black (additional cost)

12 Customer Sign Off

ADP will send custom drawings for approval within 24-48hrs.

Modular Waverley configurations are endless! Here are some example configurations and how to order:

Example 1

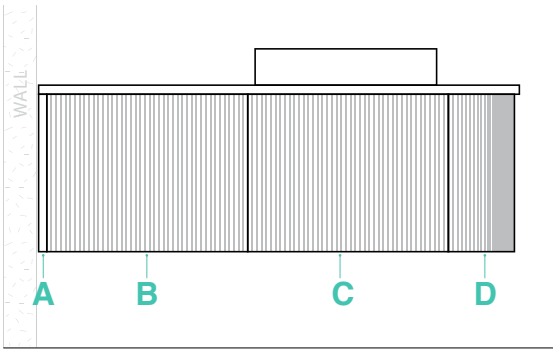

Modules ordered from Left to Right:

- Module A: 16mm End Panel
- Module B: 446mm Drawer
- Module C: 446mm Drawer
- Module D: Curved end
- Module E: NONE

Other details specified:

- Basin Position:** Over right hand drawer (module C)
- Installation Configuration:** Left End against wall
- Benchtop Configuration:** Right end curved (Left end straight)



Example 2

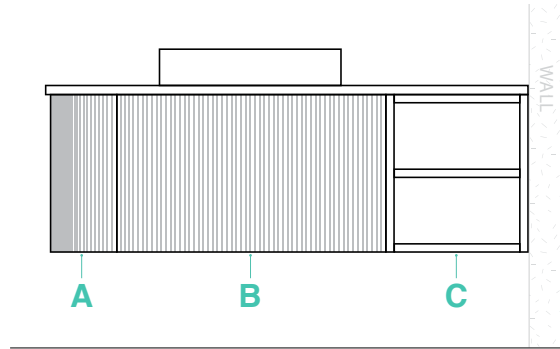

Modules ordered from Left to Right:

- Module A: Curved End
- Module B: 598mm Drawer
- Module C: 300mm Open Shelf
- Module D: NONE
- Module E: NONE

Other details specified:

- Basin Position:** Over drawer (Module B)
- Installation Configuration:** Right End against wall (no end panel needed with open shelf)
- Benchtop Configuration:** Left end curved (Right end straight)



Example 3

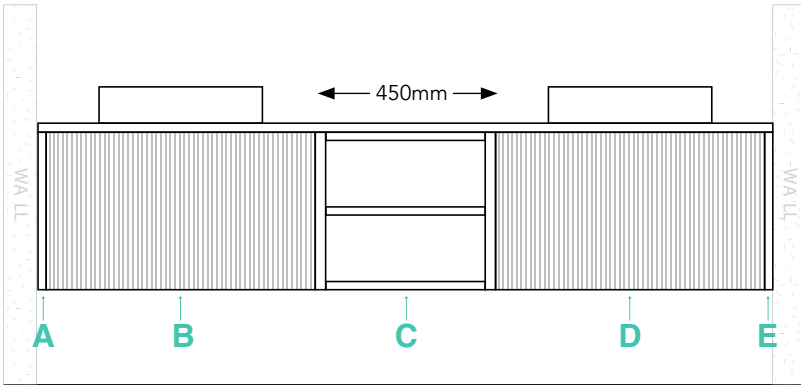

Modules ordered from Left to Right:

- Module A: 16mm End Panel
- Module B: 598mm Drawer
- Module C: Custom length Open Shelf at 450mm
- Module D: 598mm Drawer
- Module E: 16mm End Panel

Other details specified:

- Basin Position:** Over both drawers (Module B & D)
- Installation Configuration:** Between walls
- Benchtop Configuration:** Both ends straight

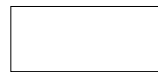

Example 4

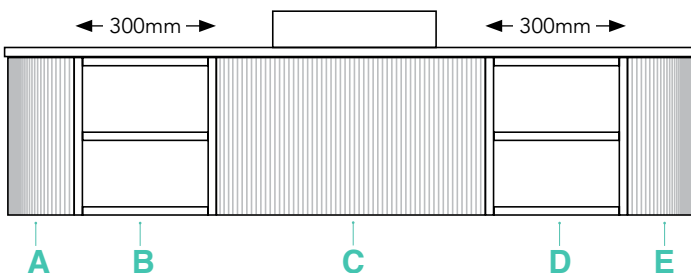

Modules ordered from Left to Right:

- Module A: Curved End
- Module B: 300mm Open Shelf
- Module C: 598mm Drawer
- Module D: 300mm Open Shelf
- Module E: Curved End

Other details specified:

- Basin Position:** Over drawer (Module C)
- Installation Configuration:** Freestanding
- Benchtop Configuration:** Both ends curved





Components used (from Left to right)

A - Custom Length Open Shelf at 450mm
Florentine Walnut Woodmatt cabinet finish

B - 598mm wide Drawer
Florentine Walnut Woodmatt cabinet finish
Matte White Aria Handle

C - 146mm Curved End
Florentine Walnut Woodmatt cabinet finish

Right end curved, left end straight
Frosty Carrina Caesarstone benchtop

Patty Above Counter Basin
Matte White

Soul Tapware
Brushed Copper





Perfect solution for
in between wall installation

Use 16mm End Panels
when installing drawers
against a wall

Create a custom width vanity
for between wall installation by
customising width of Open Shelf

Components used (from Left to right)

A - 16mm End Panel
Polar White Silk Matte

Robbie Above Counter Basin
Gloss White

B - 598mm wide Drawer
Ultra White Matte cabinet finish
Matte White Francis Handle

Soul Tapware
Brushed Brass

C - Custom Length Open Shelf at 420mm
Natural Oak Ravine cabinet finish

D - 598mm wide Drawer
Ultra White Matte cabinet finish
Matte White Francis Handle

E - 16mm End Panel
Polar White Silk Matte

Both ends straight / between walls